

GENERAL DESCRIPTION

Spectrol's standard 3/4-inch and 1-1/4-inch rectangular trimming potentiometers, the Models 43 and 70, may be easily panel mounted through the use of Spectrol Model 6 Panel Mount Adapters. The adapters are designed to convert

these standard trimmer models into panel mount trimmers in a quick, convenient, and economical manner. Assembly with the trimmer is accomplished by snap-in, providing for minimal installation time.

HOW TO ORDER THE MODEL 6 \*

Models can be ordered from this specification sheet by stating:

- 6 - X - X**
- Basic Model \_\_\_\_\_
- Trimmer Size \_\_\_\_\_
1. Fits Spectrol Model 43 or Trimmer .750 L, .190W, .250H
  2. Fits Spectrol Model 70 or Trimmer 1.250 L, .190W, .315H
- Shaft Extension \_\_\_\_\_
0. No Shaft
  1. Shaft Flush with Bushing
  2. .575 Shaft Extension
  3. .875 Shaft Extension

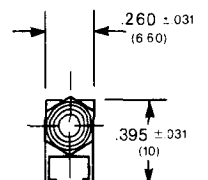
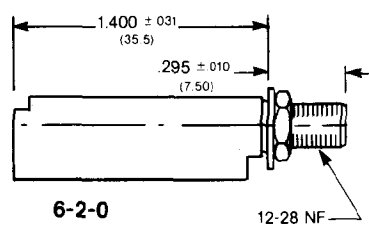
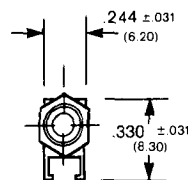
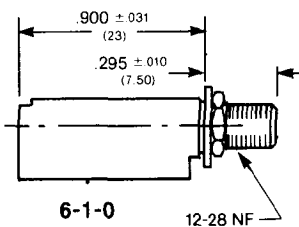
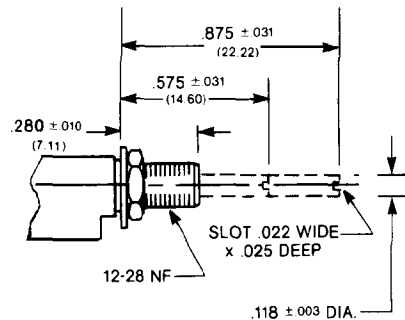
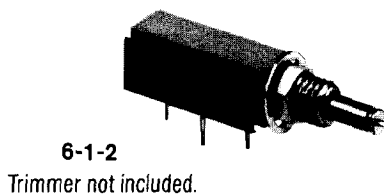
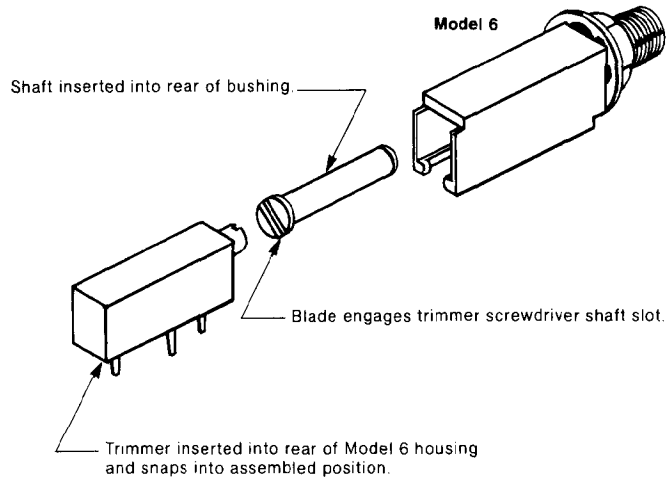

Shaft dimensions apply to 6-1-X and 6-2-X versions

BASIC DIMENSIONS ARE IN INCHES  
MILLIMETER DIMENSION IN PARENTHESES

\* Standard Distributor Product



4051 Greystone Drive  
Ontario, California 91761  
(909) 923-3313 • FAX: (909) 923-6765